

USA Measurements

"We Outmeasure the Competition"

US-M5 INDICATOR USER'S MANUAL

Portable Static Weighing Indicator



TABLE OF CONTENTS

Safety Precautions.....	1
Preparations and Set Up.....	1
Features.....	2
Technical Parameters.....	2
Specifications.....	3
Power Supply.....	3
Displays.....	4
Display and Key Descriptions.....	5
Operating Instructions.....	6-7
Calibration.....	8
Indicator Parameter Settings.....	9-11
Weighing/Printing Mode.....	12
Print Format.....	13
Connectors.....	14
Communication Settings.....	15
Printer.....	16
Troubleshooting.....	17
Contact Us.....	18

SAFETY PRECAUTIONS

For safe operation of the weighing indicator, please follow these instructions:

- Calibration inspection and maintenance of the indicator are prohibited by non-professional staff
- Please ensure that the indicator rests on a stable surface
- The indicator is a piece of static sensitive equipment; Please cut off power during electrical connections
- Touching the internal components by hand is prohibited
- DO NOT exceed the rated load limit of the unit
- DO NOT step on the unit
- DO NOT jump on the scale
- DO NOT use this product if any of the components are cracked
- DO NOT use for purposes other than weight taking
- To avoid damaging the battery do not keep charger plugged in once battery is fully charged
- Make sure the weight is not over the Max capacity as it could damage the load cell inside
- Material that has a static electric charge could influence the weighing. Discharge the static electricity of the samples, if possible. Another solution to the problem is to wipe both sides of the pan and the top of the case with an anti-static agent

Please take anti-static prevention measures

Any accumulated charge on the body of the human operator should be discharged first before opening the protective container with ESDS devices inside. The discharge can be accomplished by:

- Putting a hand on a grounded surface or, ideally, by wearing a grounded Anti-static Wrist Strap and an Anti-static Mat

PREPARATION & SET UP

- Plug into a wall outlet to avoid interference with other wirings
- Turn on the balance while there is no load
- We suggest to warm-up the balance by powering on 5 minutes before use for accurate weighing
- Calibration may be required before weighing when the balance is initially installed or moved from a location

FEATURES

- Designed to work with static axle scales
- Gross weighing and accumulative weighing modes
- LCD display (size: 5.3in x 1.4in)
- Tare, Zero, Print, Save, Check, and Delete functions
- Kg and lb weighing units
- Built-in needle printer
- Different printing formats
- 6v/4.5Ah Battery and 9v/1.2A adapter
- Can connect to a secondary large display/scoreboard
- Can connect with up to 4 weighing pads
- Shows individual scale/pad percentage of the total weight
- Manual and automatic printing modes
- Date and time can be set easily
- Can connect to a PC or printer for data logging
- Wireless capability (optional)
- Splash proof keyboard and display

TECHNICAL PARAMETERS

- Sensitivity : $0.5\mu\text{V/d}$
- Input voltage: -30 to +30mV DC
- Accuracy class : III
- Initial zero range : $\pm 10\% \text{Max}$
- Manually zero range : $\pm 2\% \text{Max}$
- Zero Range : 100% Max
- Zero Tracking : 0.5d/s
- Excitation circuit : VDC, 6 wire connection, Maximum connect 24 load cell of 350Ω
- AC power: AC 100-250VAC, 50/60HZ (use only the 9V adapter supplied)
- Operation temperature : $-10^{\circ}\text{C} \sim +40^{\circ}\text{C}$
- Operation humidity: $\leq 90\% \text{RH}$
- Storage temperature : $-10^{\circ}\text{C} \sim +40^{\circ}\text{C}$

SPECIFICATIONS

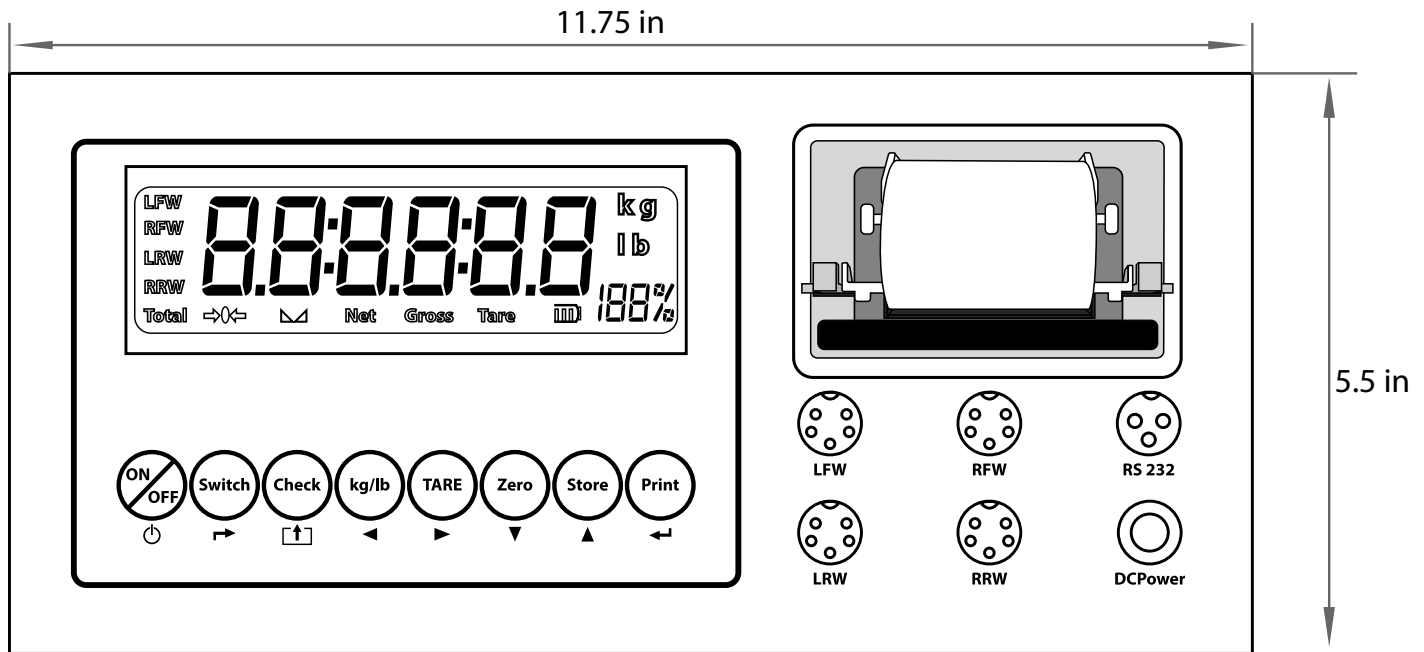

FIGURE 1: INDICATOR MEASUREMENTS



POWER SUPPLY

Battery







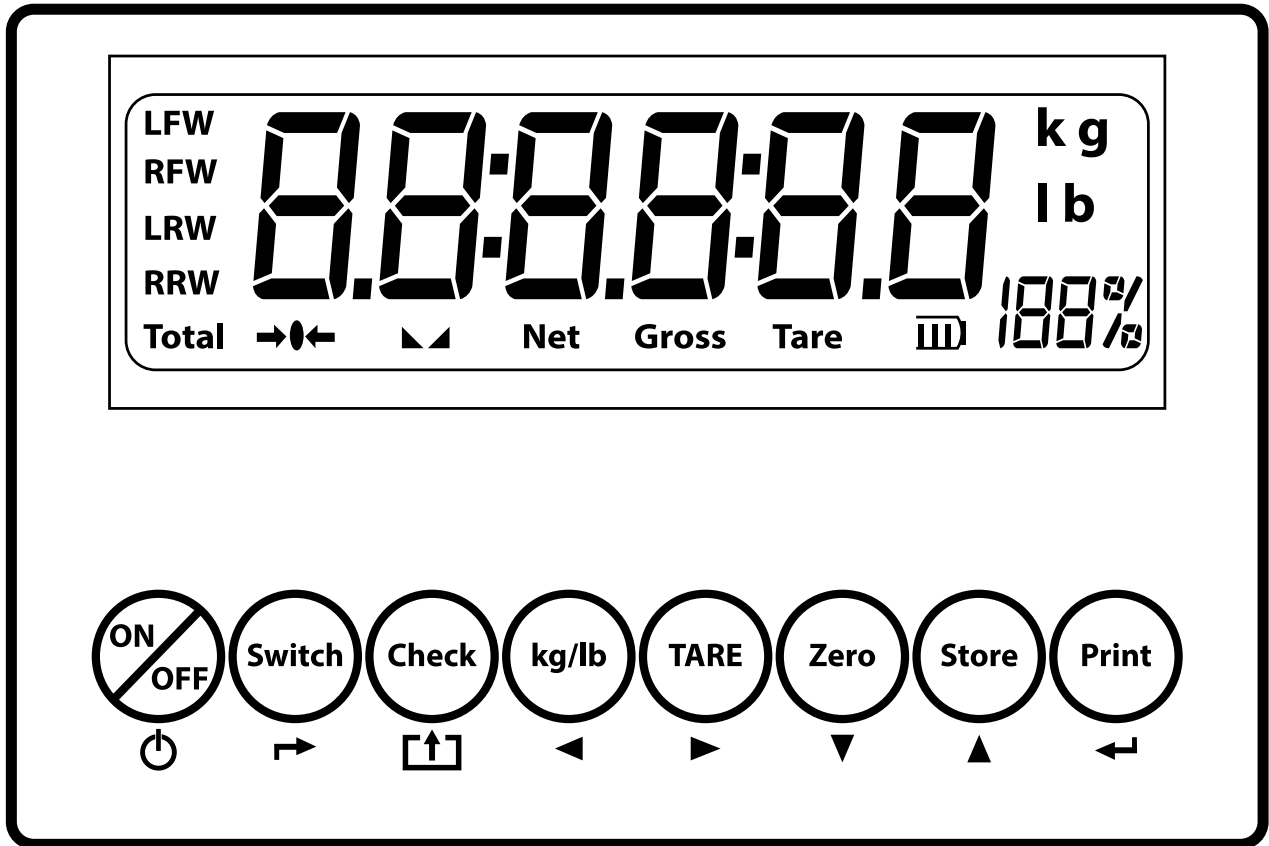

Your indicator comes with a rechargeable battery, please charge the internal battery fully before first time use. A 110 to 220V AC adapter should be provided with your indicator. Please use only the AC adapter provided to prevent damage to your indicator.

- When you use the internal battery for the first time, you should charge the battery fully, to prevent low voltage resulted from self leakage of battery
- If the battery is not used for long time, remove to avoid leakage
- To keep the battery in best condition, fully discharge the battery every month by leaving the indicator on until the indicator powers off, and then recharge fully
-  symbol will indicate the battery's charge
-  symbol indicates that the battery needs to be charged

US-M5 DISPLAY



DISPLAY AND KEY DESCRIPTION

ON/OFF	Powers the Indicator On or Off if held for 2 seconds
SWITCH	Switch the weight between the pad weight and the total weight
CHECK	Check and read the saved weight data to print
KG/LB	Shifts between weighing units (kg/lb)
TARE	1. Zero's the scale. Used when using a container to hold objects 2. Clears the tare to see the gross weight
ZERO	Zero's the scale
STORE	In accumulative weighing mode it accumulates the axle weight and prints the weight data
PRINT	1. Print data 2. Works with the switch button to enter the calibration menu
Total	Shows you are in Accumulation mode
	The scale is at zero
	The scale is stable
Net	Shows you are in Net weight mode (without tare)
Gross	Shows you are in Gross weight mode (includes tare); default mode
Tare	Shows you have tared the scale
	Indicates the charge of the battery
lb	The weight is shown in pounds
kg	The weight is shown in kilograms
	Shows the percentage of weight on the pad out of the total weight
LFW	The weight of the Left front wheel
RFW	The weight of the Right front wheel
LRW	The weight of the Left rear wheel
RRW	The weight of the Right rear wheel
	Power
	Back
	Save and Exit
	Arrow keys
	Return/Enter

OPERATING INSTRUCTIONS

Power On

- Turn on the power by pressing the power button for 2 seconds. Once on, the scale will flash the voltage and then begin to auto-check and count down from 0-9 sequentially before entering the weighing mode

Note: Anything on the scale before powering on will automatically be tared out.

Zeroing

- The zero function is used only when the scale is empty and is not at gross zero due to material build up
- Pressing the ZERO key will reset your scale to 0
- Depending on what your manual zero range parameter is set to, you can zero out any number within your set selection, after that you will receive an error and will need to tare out the weight

Unit Selection

- To switch between measuring units (kg or lb) press the KG/LB key

Tare Function

- The Tare function is used when you only wish to see the current change in weight, not the entire amount of weight that is on the scale
- When the indicator is in normal gross mode pressing the TARE key will Tare the current weight on the scale and enter the net mode →()←
- To exit Tare mode press the TARE key again to enter gross mode

To use a pre-set tare weight

- Press and hold the tare key for 2 seconds
- Input the tare weight using the arrow keys
- Press print key to confirm

Check

- The check key is used check previously saved weights
- In weighing mode, press CHECK key to show " [#####"
- ex. if there are 30 records saved it will display " [0030"
- If you wanted to check the 20th saved weight you would input " [0020" and press PRINT to check the 20th record
- The display will show "rEAd-0". Choose "1" and press PRINT
- The screen will flash the date, time, axle, tare weight and total weight one by one
- Then the screen will show "Pr int 0", enter "1" and press PRINT to print this record and go back to the Checking display " [0020"
- Press CHECK key again to exit and return to weighing mode

















Switch

- Switches the display between the total weight and each individual pad/scale weight
- Individual pad display shows the percentage of that pads load, of the total weight

Print

- If the weight on the scale is stable press the PRINT key to print the current weight







CALIBRATION PROCEDURE

1. Turn on the scale by holding the ON/OFF  key. (If the scale does not turn on, plug in the ac adapter because the battery may be low.)
2. Once on hold SWITCH  and PRINT  key to enter the indicator settings mode
3. The display will show [**F** 1] to indicate F1 settings mode, use the STORE  key to change to [**F** 2]
4. Press the PRINT  key to select and enter the F2 settings mode
5. The display will read [SCALE 1]
6. Use the arrow keys to select which scale/pad you will be calibrating (1-4)
7. Press the PRINT  key to select and enter the next setting
8. The display will read [CAL - 0], use the STORE  key to change to [CAL - 1]
9. With nothing on the scale/pad press PRINT  to Zero Calibrate, the indicator will count down from 9-0 and enter the next parameter if no errors
10. The display will show [SPAN - 0] use the STORE  key to change to [SPAN - 1], press the PRINT  key to select and enter the calibration setting
11. Use the arrow keys to enter the weight of the calibration weight you will be using (calibration weight must be at least 40% of the scale/pads capacity)
12. Load the calibration weight on the pad/scale you are calibrating
13. Once stable   press the PRINT  key to calibrate
14. The indicator will count down from 9-0 and move on to the Save parameter [SAVE - 0]
15. Press STORE  to change to [SAVE - 1], then save your calibration by pressing PRINT 
16. The indicator will display [**F** 2], Press CHECK  to exit the settings mode and go back to the weighing mode
17. The display will show the value of the calibration weight on the scale
18. Unload the scale; the display should read [000000]
19. If no errors the scale has now been calibrated
20. Repeat process until all pads/scales have been calibrated and saved

INDICATOR PARAMETER SETTINGS



This indicator has 5 different setting modes, [F 1], [F 2], [F 3], [F 4] & [F 5]. Each mode changes different indicator parameters.

To enter calibration/parameter settings, follow the procedure below:

1. Press and hold the SWITCH and PRINT key at the same time for 2 seconds
2. Navigate through the setting modes (F1 to F5) by using the arrow keys and return keys as labeled under each indicator button (, , , , )
3. Press the PRINT  key to enter/edit the parameter setting
4. Press the CHECK  key to save and exit settings at any time

F 1 Menu

Setting working mode, unit, decimal, graduation, and capacity

Step	Parameter	Display	Settings/Options
	Enter F1 Menu	F 1	
1	Mode	Mbde 2	Choose how many weighing pad's you'll be using Options: 1/2/3/4
2	Unit	Unit-0	Choose default unit 0=kg 1=lb
3	Decimal setting	dot--2	0 = no decimal 1 = #.# 2 = #.## 3 = #.### 4 = #.####
4	Graduation Setting (readability of the least significant digit)	E - 05	Options: 1/2/4/10/20/50 Example with no decimal places (ie step 3=0) 1 = 1 lb 2 = 2 lb 5 = 5 lb 10 = 10 lb 20 = 20 lb 50 = 50 lb
5	Max Capacity	FULL-0	0 = do not change the max capacity 1= change the max capacity ex. If step 2=0 and step 3=2 when changing max capacity 0100.00 = 100kg Then press  to save your settings

F 2 Menu

Setting the Choosing a pad to calibrate, zero calibration, loading calibration, and saving

Step	Parameter	Display	Settings/Options
	Enter F2 Menu	F 2	←
6	Pad Choice	SCALE 1	Choose a pad/scale to calibrate Options: 1/2/3/4
7	Zero Calibration	CAL--0	0 = do not calibrate 1 = calibrate Note: when 1 is selected the indicator will count down from 9-0 and move on to the next setting
8	Calibration	SPAN-0	When ready for calibration, setting the span tells the indicator the weight you will be calibrating the scale with 0 = do not set the span 1 = set the span Use the arrow keys to set your calibration weight and when done load your calibration weight to the scale Once stable ►◄ press ← to calibrate The indicator will count down from 9-0 and move on to the Saving parameter (Select 1 and press print to save your calibration settings)
9	Save	SAVE-0	0 = do not save calibration 1 = save calibration

F 3 Menu

Step	Parameter	Display	Settings/Options
	Enter F3 Menu	F 3	←
10	Axle Number	ALE-02	Set the number of axles (for use with accumulation mode)
11	Cargo Number	SN--00	Set the cargo number
12	Printing Format	PF - 1	0 = No printing 1 = Normal printing format 2 = Accumulative printing format * See page 13 for examples
13	Printing Method	PM - 1	0 = Manual 1 = Automatic *Manual is recommended for the most precise results
14	Printing Coupon	PC - 1	Printing coupon numbers setting Options: 1/2/3
15	Baud Rate	baud- 1	Options: 1/2/3/4/5/6/7/8 0 = 600 1 = 1200 2 = 2400 3 = 4800 4 = 9600 5 = 19200 6 = 38400 7 = 57600 8 = 115200
16	Communication Settings	CP - 1	0 = Communication off 1 = Communication format 1 for PC 2 = Communication format 2 for second display (YAO HUA MODEL) 3 = Communication format 3 for second display (TOLEDO MODEL)

Step	Parameter	Display	Settings/Options
17	Automatic Power Off	OFF-00	00 = turn off auto power off 10 = power off automatically if no change within 10 min 30 = power off automatically if no change within 30 min 60 = power off automatically if no change within 60 min
18	Back Light	bl--00	00 = Backlight on 10 = Backlight off after 10 seconds
19	Date Format	date-0	0 = year, month, day 1 = month, day, year 2 = day, month, year
20	Date	3007.13	Set according to previous parameter
21	Time	14-13-20	Set using Military time

F 4 Menu

Step	Parameter	Display	Settings/Options
	Enter F4 Menu	F 4	←
22	Records	5-0560	Set how many records/weights you want your indicator to store Max. the indicator can store is 2000 cps.
23	PCB	HE-10A	PCB version 1.0A
24	Software	SE-100	Software version 1.00
25	LFW	LFBcode	Check the left front wheel ad code
26	RFW	rFBcode	Check the right front wheel ad code
27	LRW	LrBcode	Check the left back wheel ad code
28	RRW	rrBcode	Check the right back wheel ad code

F 5 Menu

Step	Parameter	Display	Settings/Options
	Enter F5 Menu	F 5	←
29	Delete Weighing Records	dELA-0	0 = Do not delete the weighing record 1 = Delete the weighing record
30	Delete All	dEAL-0	0 = Do not delete all the records 1 = Delete all the records

WEIGHING/PRINTING MODES

In the Parameters you can set to have your printer print automatically or manually, we recommend setting to manual (F3 [PM - 0]) for best results.

Normal Weighing mode:

- In the F3 menu set the Printing Format to "1" [PF - !]
- In this mode you have the option of using 1-4 pads [MbdE 3]

Example : There are 3 weighing pads connected to the indicator to weigh an airplane.

1. The pads should connect with LFW,LRW,RRW interfaces
2. Parameter settings: F1 Working Mode setting: "3" [MbdE 3]
F3 Printing Format setting: "1" [PF - !]
3. Drive the plane on the pads. You can press the "SWITCH" key to switch between displaying the total weight, and the weight of each pad, shown with the percentage of that pads load of the total weight
 - If [PM - 1] Printing and Saving will be done automatically once the load is stable
 - If [PM - 0] Press the "PRINT" key to print results

Accumulative weighing mode:

- In the F3 menu set the printing format to "2" [PF - 2]
- In this mode you have the option of using 2 or 4 pads [MbdE 2]
- The Print mode must be set to manual to function correctly [PM - 0]
- Drive axle on weighing pads
- Press the "**STORE**" key to accumulate the axle's weight and print the axle's data
- Repeat steps until all axles have been weighed
- Then press the "**PRINT**" key to accumulate weights and print the total

Example: There are 2 weighing pads connected to the indicator to weigh a truck with three axles.

1. The pads should connect with LFW, RFW interfaces
2. Parameter settings:

F1 Working Mode setting: "2"	[MbdE 2]
F3 Printing Format setting: "2"	[PF - 2]
F3 Printing Mode setting: "0"	[PM - 0]
F3 Axle Number setting: "3"	[ALE-03]
3. Measure spacing between tire sets in an axle and place weighing pads accordingly
4. Drive the first axle of the truck on the weighing pads. When stable press the "**STORE**" key to begin accumulation by storing the weight data and printing the first axle's results
5. Drive the second axle of the truck on the weighing pads and when stable press the "**STORE**" key to accumulate and store the second weight data and print the second axle's results
6. Drive the third axle of the truck on the weighing pads and when stable press the "**STORE**" key to accumulate and store the third weight data and print the third axle's results
7. Then press the "**PRINT**" key to accumulate all three axle weights and print the total weight of the truck

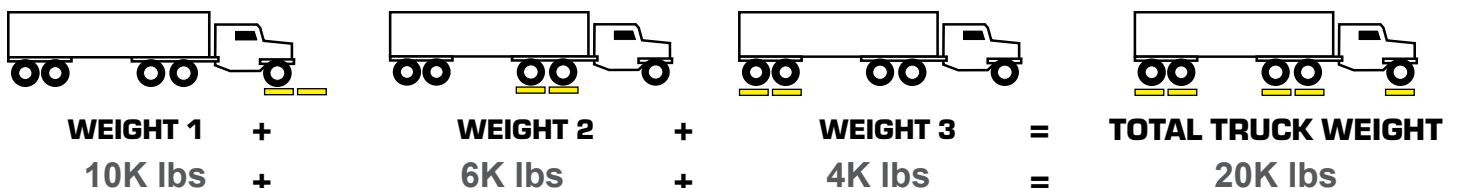

PRINT FORMAT

Normal Printing Format

Single pad: WEIGHTING REPORT	Double pads: WEIGHTING REPORT	Three pads: WEIGHTING REPORT	Four pads: WEIGHTING REPORT
-----	-----	-----	-----
NO. : 0575	NO. : 0575	NO. : 0575	NO. : 0575
Date: 2013-11-02	Date: 2013-11-02	Date: 2013-11-02	Date: 2013-11-02
Time: 09:59:04	Time: 09:59:04	Time: 09:59:04	Time: 09:59:04
Vehicle:	Vehicle:	Vehicle:	Vehicle:
Cargo:34	Cargo:34	Cargo:34	Cargo:34
LFW: 429.0kg	LFW:429.0kg	FW: 429.0kg	LFW: 429.0kg
-----	RFW:413.5kg	LRW: 319.0kg	RFW: 413.5kg
Gross: 429.0kg	Axle1:842.5kg	RRW: 293.0kg	Axle1: 842.5kg
Operator:	-----	Axle2: 612.0kg	LRW: 319.0kg
	Gross: 842.5kg	-----	RRW: 293.0kg
	Operator:	Gross: 1041.0kg	Axle2: 612.0kg
		Operator:	-----
			Gross: 1454.5kg
			Operator:

Accumulative Printing Format

Double pads:(Double axles) WEIGHTING REPORT	Four pads:(Four axles) WEIGHTING REPORT
-----	-----
NO. : 0594	NO. : 0594
Date: 2013-11-02	Date: 2013-11-02
Time: 11:10:41	Time: 11:10:41
Vehicle:	Vehicle:
Cargo:34	Cargo:34
LW: 420.5kg	LFW: 420.5kg
RW: 419.5kg	RFW: 419.5kg
Axle01: 840.0kg	Axle01: 840.0kg
LW: 309.5kg	LRW: 309.5kg
RW: 297.0kg	RRW: 297.0kg
Axle02: 607.0kg	Axle02: 607.0kg
-----	LFW: 420.5kg
Gross: 1447.0kg	RFW: 419.5kg
Operator:	Axle03: 840.0kg
	LRW: 309.5kg
	RRW: 297.0kg
	Axle04: 607.0kg

	Gross: 2894.0kg
	Operator:

CONNECTORS

Connecting load cells to the indicator

- US-M5 can connect with 4 weighing pads or 24 pcs of load cells of 350Ω at most

QUICK DISCONNECT AS SHOWN BELOW:

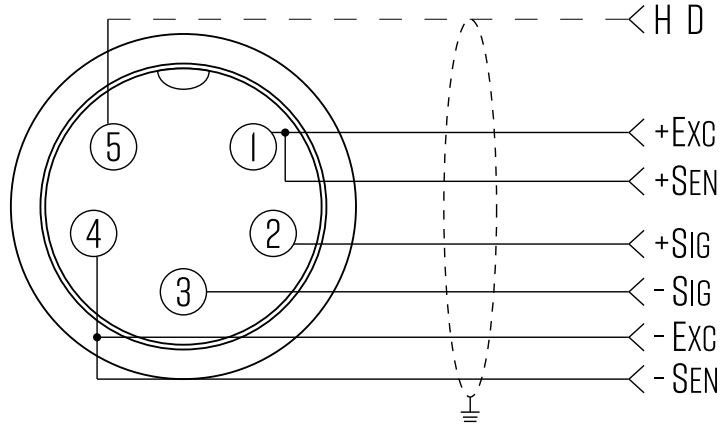

The number of weighing pads and load cells corresponds to the weighing modes. If the pads or load cells are not connected properly the indicator will not function properly. Please use the following table to connect your pads correctly.

INNER TERMINAL BLOCK CONNECTION DIAGRAM

Weighing Pad #	Load Cell Connection	Weighing Mode
1	LFW	[Mode 1] Setting "1"
2	LFW, RFW	[Mode 2] Setting "2"
3	LFW, LRW, RRW	[Mode 3] Setting "3"
4	LFW, RFW, LRW, RRW	[Mode 4] Setting "4"

DB9 Connection (9 pin Serial Connector)

RS232: DB9 SERIAL CONNECTOR PINOUT

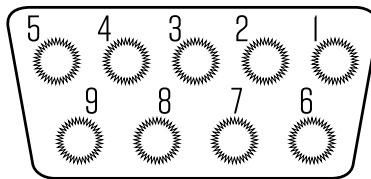

Pin function and definition are bellow:

DB9 Pin	Definition	Function
2	TXT	Transmit Data
3	RXD	Receive Data
5	GND	Ground Interface

COMMUNICATION SETTINGS

Format 1 [CP - 1]

Workable with a PC

RS232COM serial interface can receive simple ASCII command.

RS232 parameter:9600Bit/S Baud rate,8 digits,no check point,1 stop.

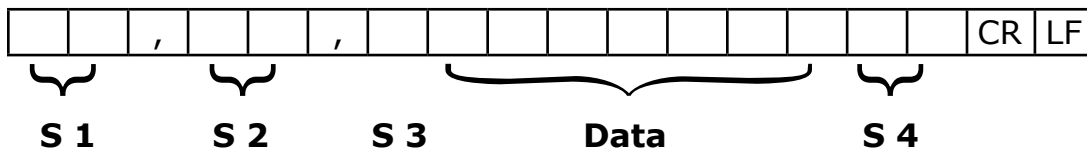

S1: weight status, ST=standstill, US=not standstill, OL=overload

S2: weight mode, GS=gross mode, NT=net mode

S3: weight of positive and negative, "+" or "-"

S4: "kg" or "lb"

Data: weight value, including decimal point

CR: carriage return

LF: line feed

Format 2 [CP - 2]

Workable with second display from Yaohua, Baud rate 600.

Format 3 [CP - 3]

Workable with second display from Toledo, Baud rate 1200.

PRINTER

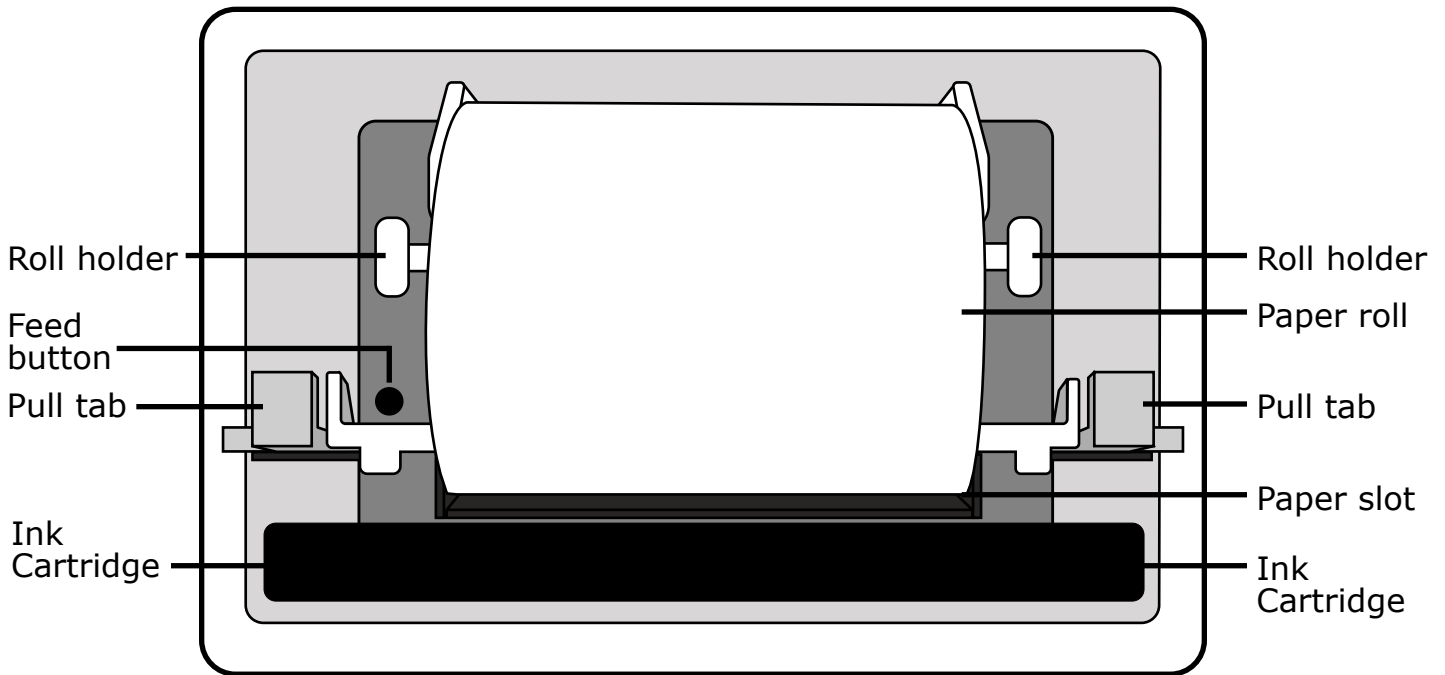

To Remove lid:

Remove lid by pressing on the lower corner tabs and squeezing while pulling outwards

To Replace Ink:

Remove lid, then squeeze and pull forward on the pull tabs to pull printer forward from indicator. Next hold ink cartridge on both sides and pull straight down. To replace, feed paper through the new ink cartridge, then align the small holes located on the left side of the ink cartridge with the gears located under the left pull tab. Push cartridge upwards into place and push printer backwards into the indicator and replace lid.

To Replace Paper:

Remove lid, then squeeze and pull forward on the pull tabs to pull printer forward from indicator. Carefully remove ink cartridge. If the paper roll is not empty use the feed button to empty the roll. Once roll is empty squeeze both sides of the roll holder and pull forward. Remove old roll from the roll holder and replace with a new paper roll. Squeeze both sides of the roll holder and replace back into the printer. Feed paper into the paper slot while holding the feed button. Then feed paper into the ink cartridge. Push cartridge upwards into place and push printer backwards into the indicator and replace lid.

TROUBLESHOOTING

Error Codes

Error	Reason	Solution
UUUUUUU	<ol style="list-style-type: none"> 1. Overload 2. Wrong connection with load cell 3. Load cell has quality problem 	<ol style="list-style-type: none"> 1. Reduce the weight 2. Check load cell connection 3. Inspect load cell; Check the input/output 4. See Q&A section
nnnnnnnn	<ol style="list-style-type: none"> 1. Calibration is no good 2. Wrong connection with load cell 3. Load cell has quality problem 	<ol style="list-style-type: none"> 1. Make sure scale is level 2. Check load cell connection 3. Check load cell input and output resistance 4. See Q&A section
Err 1	During calibration, weight is not used or the weight is above the max. capacity	Use correct weight within the defined range
Err 2	During calibration, the weight is below the minimum required weight	The calibration weight minimum is 10% of the max. capacity set in C04. Recommended to use 60%-80% of max. capacity if possible
Err 3	During calibration, the input signal is negative	<ol style="list-style-type: none"> 1. Check all wire connections 2. Check load cell 3. Recalibrate 4. PCB replacement needed if steps 1-3 fail
Err 4	During calibration signal is unstable	After the platform is stable, start calibration
Err 5	EEPROM Error	Change PCB
Err 6	Exceed Zero Range	See Q&A section
Err 10	Scale was not stable when Zeroed	Wait for the scale to stabilize before zeroing
Err 11	Zero function can not be used in Tare mode	Go back to gross weighing, by pressing Tare then you can Zero
Err 12	Out of the zero range	Move the extra load
Err 15	Scale wasn't stable when Tared	Tare once the load is stable
Err 16	Tared without a load	Add your load, then tare
Err 17	Out of tare range	Decrease the tare weight
Err 25	The record you are trying to check does not exist	Assure the record you are trying to check exists
Err 30	Printing format wrong in accumulative weighing mode	Set Printing format to setting "2"
Err 31	Working mode wrong in accumulative weighing mode	Set Working mode setting to either "2 or 4"
Err 32	You are weighing over max. capacity or you tried to print while the scale was unstable	<p>Reduce weight on the scale</p> <p>Print after scale has stabilized</p>
Err 33	Display Error, Printing with the indicator in accumulative weighing mode	Print the total weight after accumulating the weight of axles
Err 34	Printing error in normal Weighing mode	Wait for the load to be stable, then print
Err 35	Printing format wrong in normal weighing mode	Set Printing format to Setting "1"

CONTACT US

Please e-mail sales@usameasurements.com for any sales related questions.

Please e-mail support@usameasurements.com for any support related questions.

Don't forget to visit our website at:

www.usameasurements.com